

E80-R Miniature Rocker and Paddle Switches

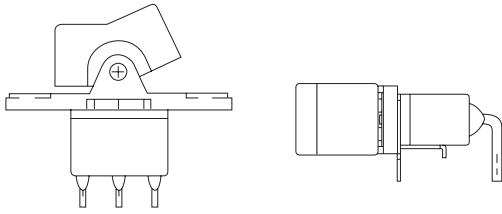

SPECIFICATIONS

CONTACT RATING: 6A @125 VAC or 28 VDC (Q terminal)
 ELECTRICAL LIFE: 50,000 make-and-break cycles at full load
 CONTACT RESISTANCE: 10 mΩ max. initial @2-4 VDC, 100 mA
 INSULATION RESISTANCE: 1,000 MΩ min.
 DIELECTRIC STRENGTH: 1,500 V RMS @ sea level.
 OPERATING TEMPERATURE: -30°C to +85°C

MATERIALS

CASE & BUSHING- Glass filled nylon 6/6 or nylon 4/6 (UL94V-0)
 ACTUATOR - Nylon, black standard, internal o-ring
 seal standard with all actuators
 SWITCH SUPPORT- Copper alloy or steel, tin plated
 CONTACT AND TERMINAL- Copper alloy, silver plated
 TERMINAL SEAL- Epoxy



How do you build the switches you need!!

The straight terminal type , please see the (A) ;

The right angle P.C terminals, please see the (B)

(A) **E R 8 0 1 5** - **R 1 1** - **2** - **C** **Q** - **S 2 0** -

Switches Function		Actuator	Actuator Color	Termination	Contact Material	Vertical support Bracket
ER8015	SP on-none-on	R11	1 white	B solder lug	Q silver plated	(none) 11.68
ER8015A	SP on-none-(on)	R21 □	2 black(std)	C P.C 1.27width	R gold plated	
ER8016	SP on-off-on	P13	3 red	D Quick connect	G gold over silver	RoHS code □ = none H = RoHS Compliant
ER8016A	SP (on)-off-(on)	P23	4 orange	D1 wire wrap 19.05	K tin plated	
ER8016B	SP on-off-(on)		5 yellow	D3 wire wrap 10.8		
ER8017	DP on-none-on		6 green			
ER8017A	DP on-none-(on)		7 blue			
ER8018	DP on-off-on		8 brown			
ER8018A	DP (on)-off-(on)		9 gray			
ER8018B □	DP □ on-off-(on) □					
NER8015	SP on-none-on		now the available is code "1/2/3". The other please inquire first			
NER8015A	SP on-none-(on)					
NER8016	SP on-off-on					
NER8016A	SP (on)-off-(on)					
NER8016B	SP on-off-(on)					
3 way position switches						
ER818	SP3T on-on-on					

(B) **E R 8 0 1 5 P** - **R 1 1** - **2** - **Q** -

Horizon Right Angle	Vertical Right Angle	Switches Function	Actuator	Actuator Color	Contact Material	RoHS code
ER8015P	ER8015L / ER8013L	SP on-none-on	R11	1 white	Q silver plated	□ = none H = RoHS Compliant
ER8015PA	ER8015LA / ER8013LA	SP on-none-(on)	R21	2 black(std)	R gold plated	
ER8016P	ER8016L / ER8014L	SP on-off-on	P13	3 red	G gold over silver	The right angle type cannot have frame.
ER8016PA	ER8016LA / ER8014LA	SP (on)-off-(on)	P23	4 orange	K tin plated	
ER8016PB	ER8016LB / ER8014LB	SP on-off-(on)		5 yellow		
ER8017P	ER8017L / ER8011L	DP on-none-on		6 green		
ER8017PA	ER8017LA / ER8011LA	DP on-none-(on)		7 blue		
ER8018P	ER8018L / ER8012L	DP on-off-on		8 brown		
ER8018PA	ER8018LA / ER8012LA	DP (on)-off-(on)		9 gray		
ER8018PB □	ER8018LB / ER8012LB □	DP on-off-(on) □				
NER8015P	NER8015L / NER8013L	SP on-none-on	now the available is code "1/2/3". The other please inquire first			
NER8015PA	NER8015LA / NER8013LA	SP on-none-(on)				
NER8016P	NER8016L / NER8014L	SP on-off-on				
NER8016PA	NER8016LA / NER8014LA	SP (on)-off-(on)				
NER8016PB	NER8016LB / NER8014LB	SP on-off-(on)				
3 way position switches						
ER818P/ER818L/ ER812L		SP3T on-on-on				

E80-R Sealed Miniature Rocker and Paddle Switches



SPDT 2 Comm

Model No.	Switching position		
ER8015	ON	none	ON
ER8015A	ON	none	(ON)
ER8016	ON	OFF	ON
ER8016A	(ON)	OFF	(ON)
ER8016B	ON	OFF	(ON)
Term. Comm.	2-3	open	2-1

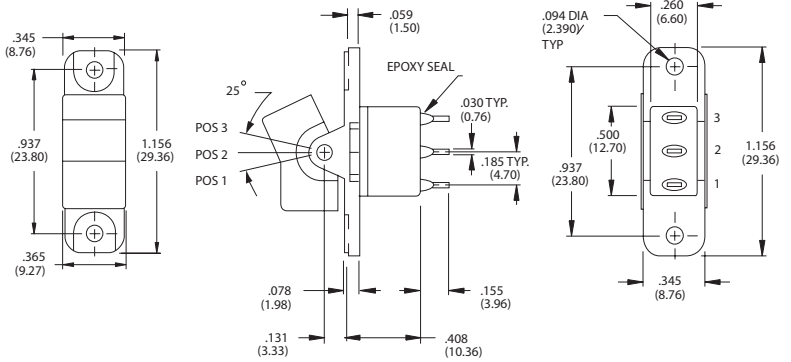

ER8015- R11-2-BQ

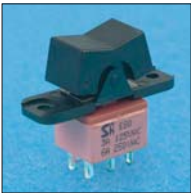

DPDT 2 Comm 5 Comm

Model No.	Switching position		
ER8017	ON	none	ON
ER8017A	ON	none	(ON)
ER8018	ON	OFF	ON
ER8018A	(ON)	OFF	(ON)
ER8018B	ON	OFF	(ON)
Term. Comm.	2-3,5-6	open	2-1,5-4
3 way switches			
ER818	ON	ON	ON
Term. Comm.	2-3,5-6	2-3,5-4	2-1,5-4

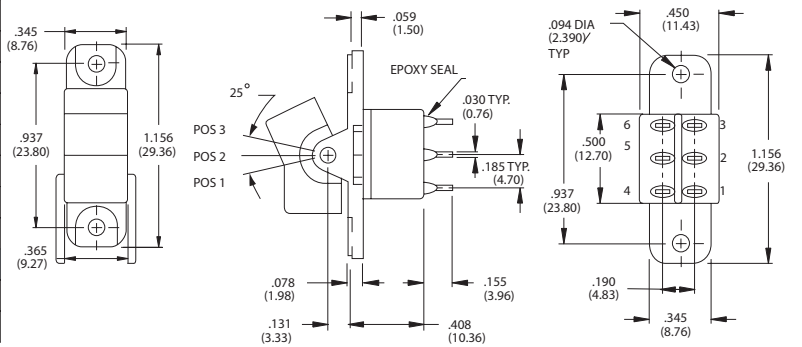

ER8017- R11-2-BQ

Please see page B6 to know more about ER818 (3-way Switches)

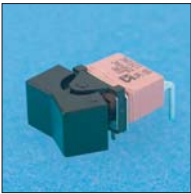

SPDT 2 Comm

Model No.	Switching position		
ER8015P	ON	none	ON
ER8015PA	ON	none	(ON)
ER8016P	ON	OFF	ON
ER8016PA	(ON)	OFF	(ON)
ER8016PB	ON	OFF	(ON)
Term. Comm.	2-3	open	2-1

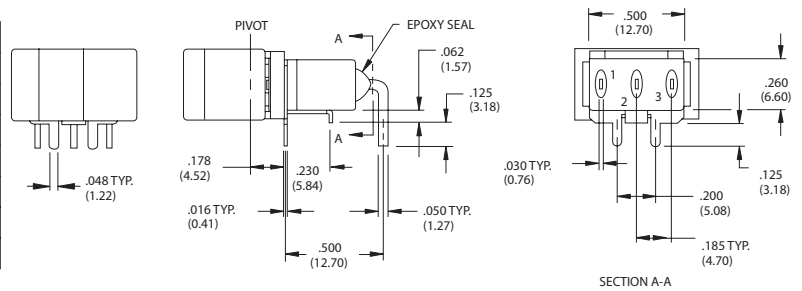

ER8015P - R11-2-Q



DPDT 2 Comm 5 Comm

Model No.	Switching position		
ER8017P	ON	none	ON
ER8017PA	ON	none	(ON)
ER8018P	ON	OFF	ON
ER8018PA	(ON)	OFF	(ON)
ER8018PB	ON	OFF	(ON)
Term. Comm.	2-3,5-6	open	2-1,5-4
3 way switches			
ER818P	ON	ON	ON
Term. Comm.	2-3,5-6	2-3,5-4	2-1,5-4

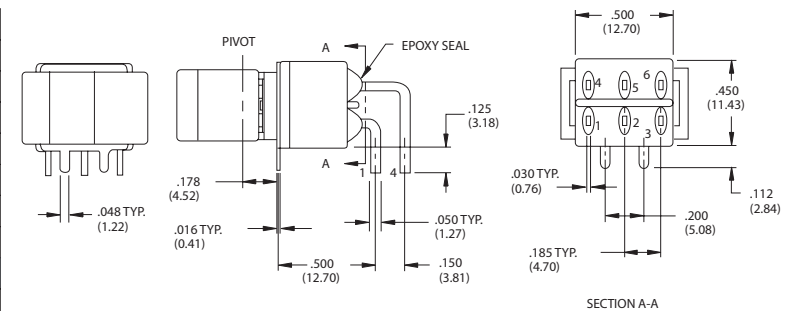

ER8017P - R11-2-Q

Please see page B6 to know more about ER818P (3-way Switches)

INDEX

TOGGLE

ROCKER

SLIDE

PUSHBUTTON

DIP

TACT

E80-R Sealed Miniature Rocker and Paddle Switches

SPDT

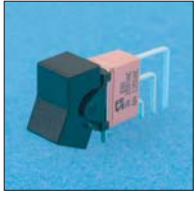

Model No.	Switching position		
ER8015L	ON	none	ON
ER8015LA	ON	none	(ON)
ER8016L	ON	OFF	ON
ER8016LA	(ON)	OFF	(ON)
ER8016LB	ON	OFF	(ON)
Term. Comm.	2-3	open	2-1

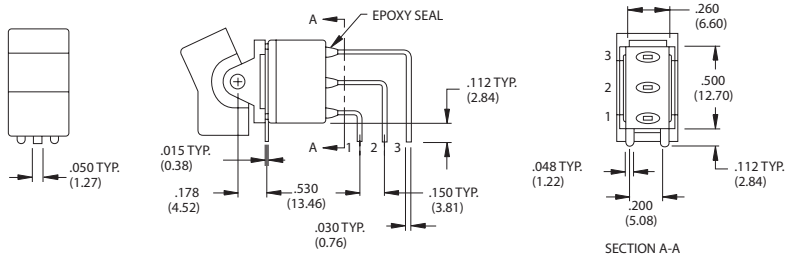

ER8015L- R11-2-Q

INDEX

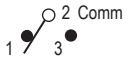

SPDT

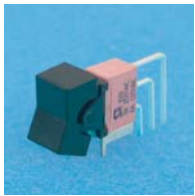

Model No.	Switching position		
ER8013L	ON	none	ON
ER8013LA	ON	none	(ON)
ER8014L	ON	OFF	ON
ER8014LA	(ON)	OFF	(ON)
ER8014LB	ON	OFF	(ON)
Term. Comm.	2-3	open	2-1

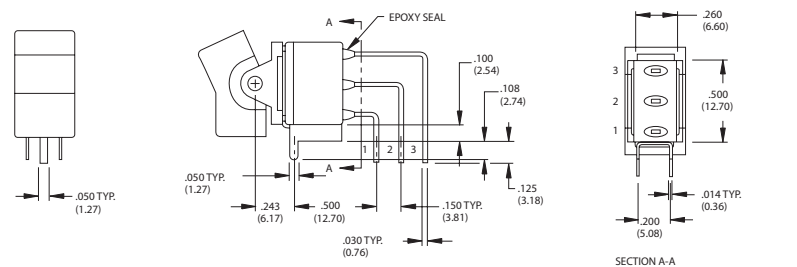

ER8013L- R11-2-Q

TOGGLE

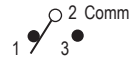

ROCKER

DPDT

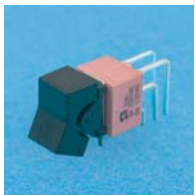

Model No.	Switching position		
ER8017L	ON	none	ON
ER8017LA	ON	none	(ON)
ER8018L	ON	OFF	ON
ER8018LA	(ON)	OFF	(ON)
ER8018LB	ON	OFF	(ON)
Term. Comm.	2-3,5-6	open	2-1,5-4
3 way switches			
ER818L	ON	ON	ON
Term. Comm.	2-3,5-6	2-3,5-4	2-1,5-4

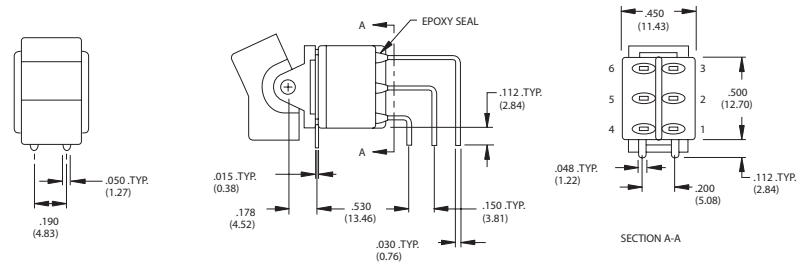

ER8017L - R11-2-Q
Please see page B6 to know more about ER818L (3-way Switches)

SLIDE



PUSH BUTTON

DPDT

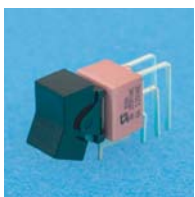

Model No.	Switching position		
ER8011L	ON	none	ON
ER8011LA	ON	none	(ON)
ER8012L	ON	OFF	ON
ER8012LA	(ON)	OFF	(ON)
ER8012LB	ON	OFF	(ON)
Term. Comm.	2-3,5-6	open	2-1,5-4
3 way switches			
ER812L	ON	ON	ON
Term. Comm.	2-3,5-6	2-3,5-4	2-1,5-4

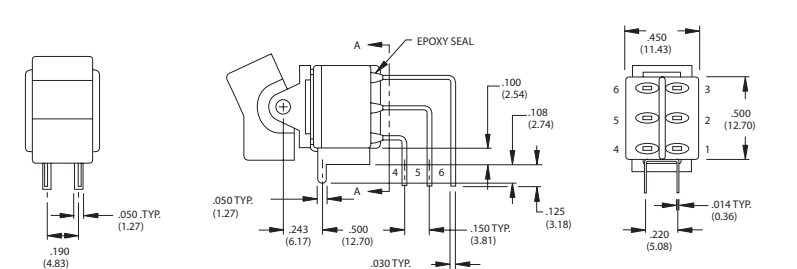

ER8011L - R11-2-Q
Please see page B6 to know more about ER812L (3-way Switches)

TACT



E80-R Sealed Miniature Rocker and Paddle Switches

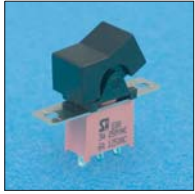

SPDT

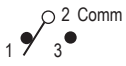

Model No.	Switching position		
NER8015	ON	none	ON
NER8015A	ON	none	(ON)
NER8016	ON	OFF	ON
NER8016A	(ON)	OFF	(ON)
NER8016B	ON	OFF	(ON)
Term. Comm.	2-3	open	2-1

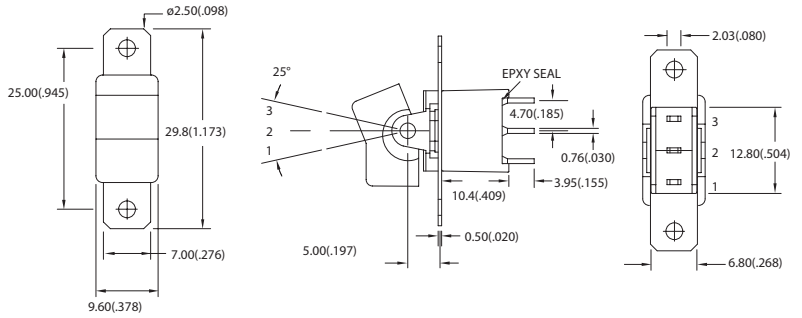

NER8015- R11-2-BQ

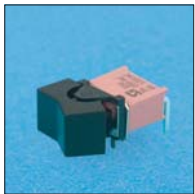

SPDT

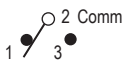

Model No.	Switching position		
NER8015P	ON	none	ON
NER8015PA	ON	none	(ON)
NER8016P	ON	OFF	ON
NER8016PA	(ON)	OFF	(ON)
NER8016PB	ON	OFF	(ON)
Term. Comm.	2-3	open	2-1

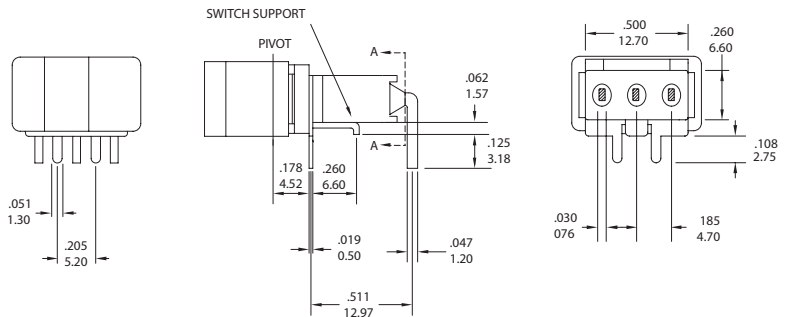

NER8015P- R11-2-Q

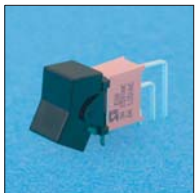

SPDT

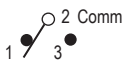

Model No.	Switching position		
NER8015L	ON	none	ON
NER8015LA	ON	none	(ON)
NER8016L	ON	OFF	ON
NER8016LA	(ON)	OFF	(ON)
NER8016LB	ON	OFF	(ON)
Term. Comm.	2-3	open	2-1

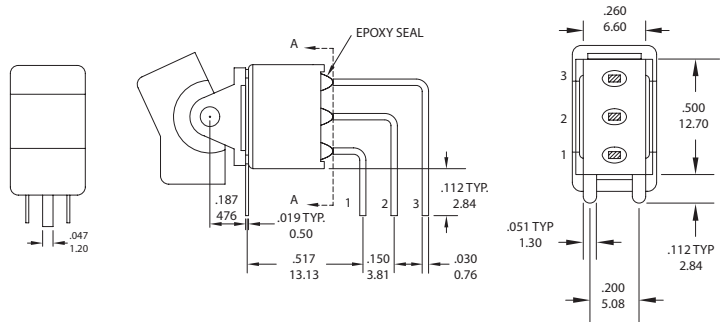

NER8015L - R11-2-Q

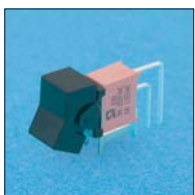

SPDT

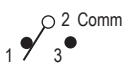

Model No.	Switching position		
NER8013L	ON	none	ON
NER8013LA	ON	none	(ON)
NER8014L	ON	OFF	ON
NER8014LA	(ON)	OFF	(ON)
NER8014LB	ON	OFF	(ON)
Term. Comm.	2-3	open	2-1

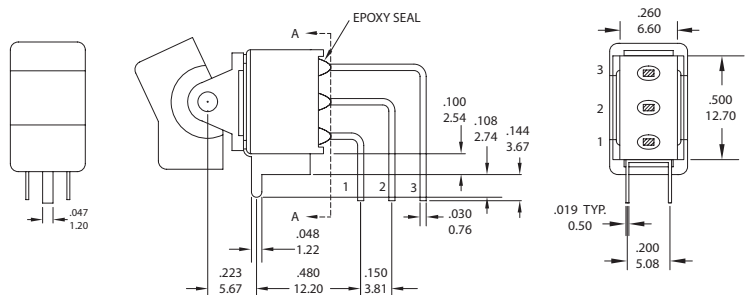

NER8013L - R11-2-Q

INDEX

TOGGLE

ROCKER

SLIDE

PUSHBUTTON

DIP

TACT

E80-R Sealed Miniature Rocker and Paddle Switches

FOR ER8015P-ER8016PB
NER8015P-NER8016PB

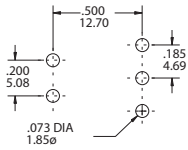

FOR ER8017P-ER8018PB

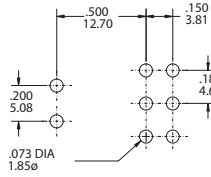

FOR ER8015L-ER8016LB
NER8015L-NER8016LB

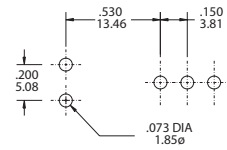

FOR ER8013L-ER8014LB
NER8013L-NER8014LB

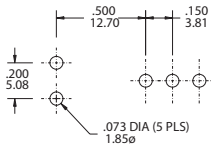

FOR ER8017L-ER8018LB

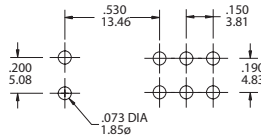

FOR ER8011L-ER8012LB

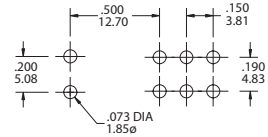

Actuator Option

R11

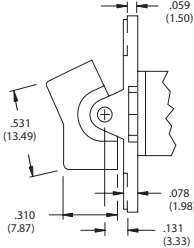
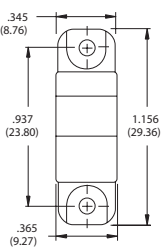

R21

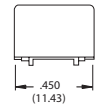
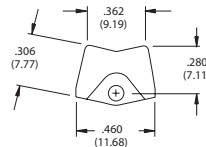

P13

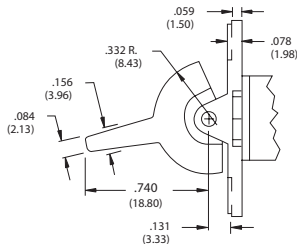
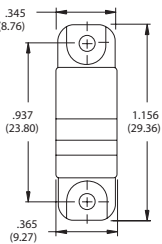

P23

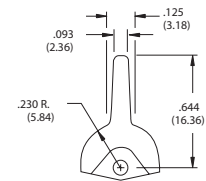

Panel Mounting

Terminal Option (only for straight type ER8015~ER8018)

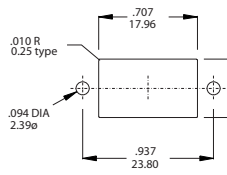

R11 / P13

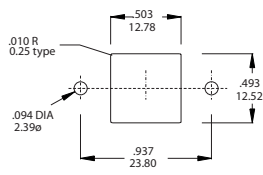

R21 / P23

B SOLDER LUG

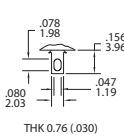

THK 0.76 (.030)

C PRINTED CIRCUIT

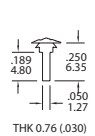

THK 0.76 (.030)

D QUICK CONNECT

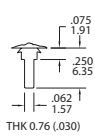

THK 0.76 (.030)

WIREWRAP

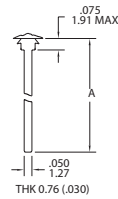

THK 0.76 (.030)

CODE	"A" dimension
D1	.750 (19.05)
D3	.425 (10.8)

CONTACT MATERIAL OPTIONS

CODE	CONTACT MATERIAL	TERMINAL MATERIAL	RATING
Q	Silver plated	Silver plated	6 A @ 125V AC or 28 V DC; 3 A @ 250 VAC
R	Gold plated over nickel plated	Gold plated over nickel plated	0.4VA MAX @ 20 V AC or DC MAX
G	Gold plated over silver plated	Gold plated over silver plated	0.4 VA MAX @ 20 V AC or DC MAX or 6 A @ 125V AC or 28 V DC; 3 A @ 250 VAC
K	Gold plated over nickel plated	Tin over nickel plated	0.4VA MAX @ 20 V AC or DC MAX

* THE K option is only for some special item. Please inquire first when you need the "K" option

VERTICAL SUPPORT BRACKET (only apply the straight type terminal: page B2 & B4)

S20 (SPDT)

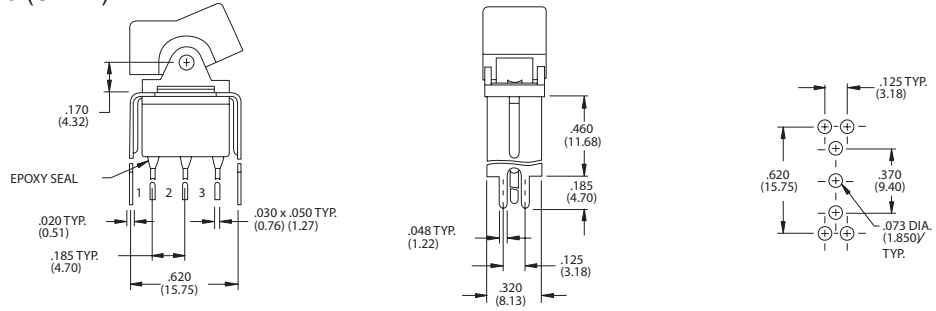

ER8015-R11-2-CQ-S20

S20 (DPDT)

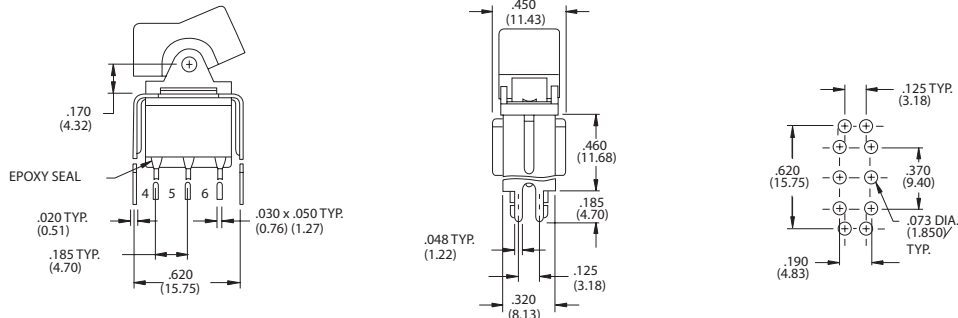

ER8017 - R11-2-CQ-S20

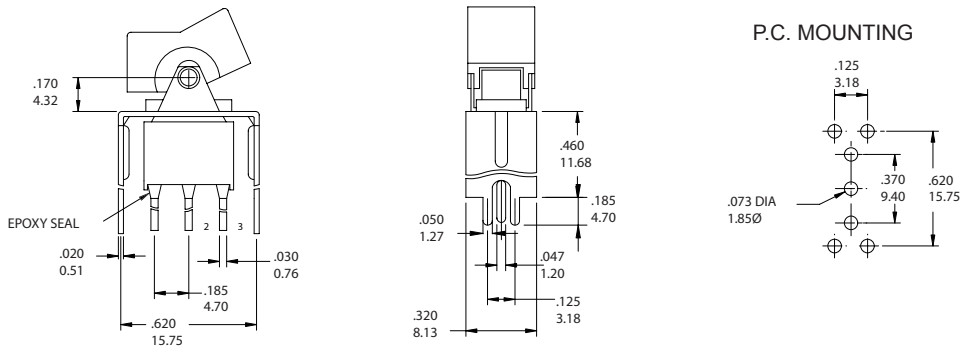

NER8015 - R11-2-CQ-S20

The information of 3-way rocker switches

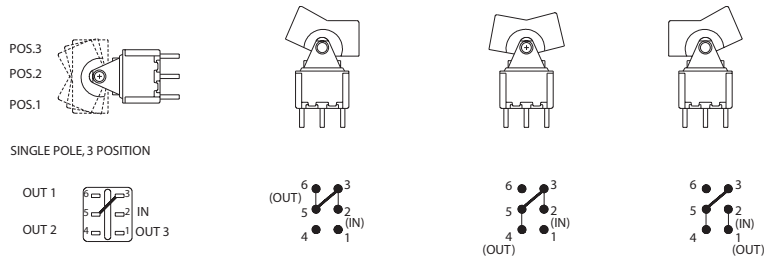

SP3T

INDEX

TOGGLE

ROCKER

SLIDE

PUSHBUTTON

DIP

TACT