

Package Dimensions

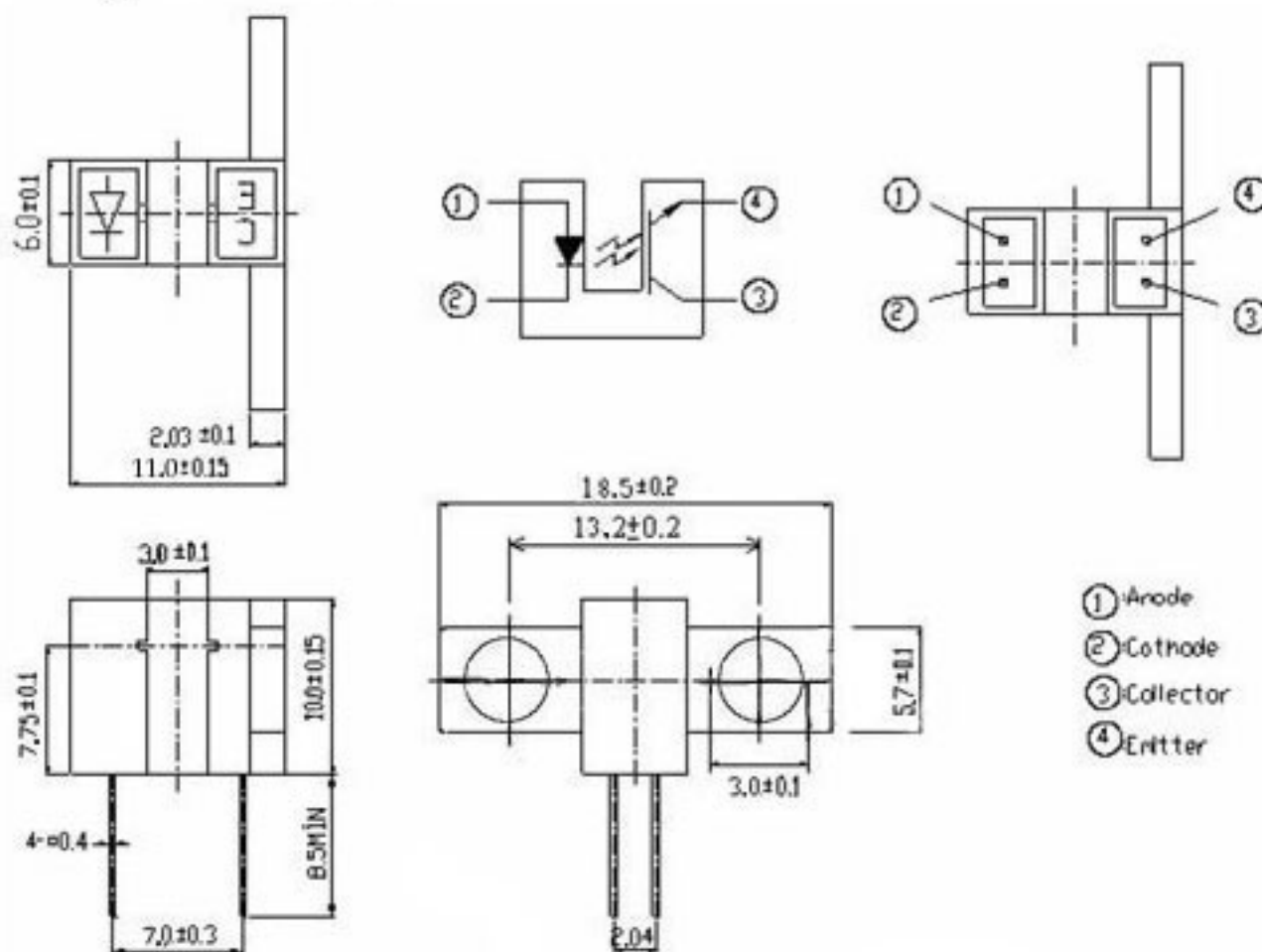

■ Absolute Maximum Ratings (Ta=25°C)

Parameter		Symbol	Ratings	Unit
Input	Power Dissipation at(or below) 25°C Free Air Temperature	Pd	75	mW
	Reverse Voltage	V _R	5	V
	Forward Current	I _F	50	mA
	Peak Forward Current (*1) Pulse width ≤ 100 μs, Duty cycle=1%	I _{FP}	1	A
Output	Collector Power Dissipation	P _C	75	mW
	Collector Current	I _C	20	mA
	Collector-Emitter Voltage	B V _{CEO}	30	V
	Emitter-Collector Voltage	B V _{ECO}	5	V
Operating Temperature		Topr	-25~+85	°C
Storage Temperature		Tstg	-40~+85	°C
Lead Soldering Temperature (*2) (1/16 inch form body for 5 seconds)		Tsol	260	°C

(*1) tw=100 μsec., T=10 msec. (*2) t=5 Sec

■ Electro-Optical Characteristics (Ta=25°C)

Parameter		Symbol	Min.	Typ.	Max.	Unit	Conditions
Input	Forward Voltage	V _{F1}	---	1.2	1.5	V	I _F =20mA
		V _{F2}	---	1.4	1.85		I _F =100mA, tp=100 μs, tp/T=0.01
		V _{F3}	---	2.6	4.0		I _F =1A, tp=100 μs, tp/T=0.01
	Reverse Current	I _R	---	---	10	μA	V _R =5V
	Peak Wavelength	λ _p	---	940	---	nm	I _F =20mA
	View Angle	2θ1/2	---	60	---	Deg	I _F =20mA
Output	Dark Current	I _{CEO}	---	---	100	nA	V _{CE} =20V, Ee=0mW/cm ²
	C-E Saturation Voltage	V _{CE(sat)}	---	---	0.4	V	I _C =2mA , Ee=1mW/cm ²
Transfer Characteristics	Collect Current	I _{C(ON)}	0.5	---	10	mA	V _{CE} =5V I _F =20mA
	Rise time	t _r	---	15	---	μsec	V _{CE} =5V
	Fall time	t _f	---	15	---	μsec	I _C =1mA R _L =1KΩ

Typical Electrical/Optical/Characteristics Curves for IR

Fig.1 Forward Current vs.

Ambient Temperature

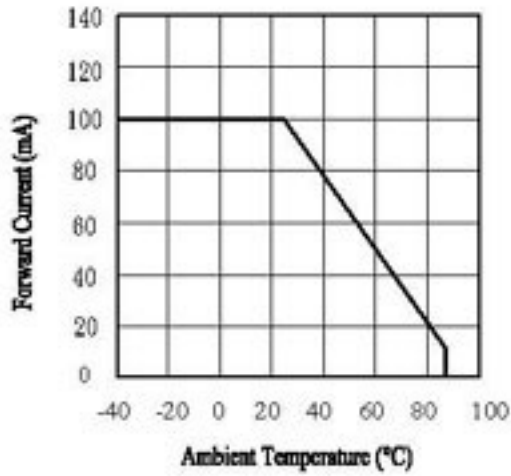

Fig.2 Spectral Distribution

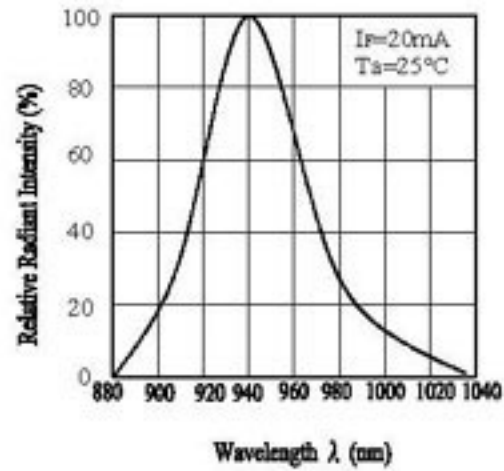

Fig.5 Relative Intensity vs.

Forward Current

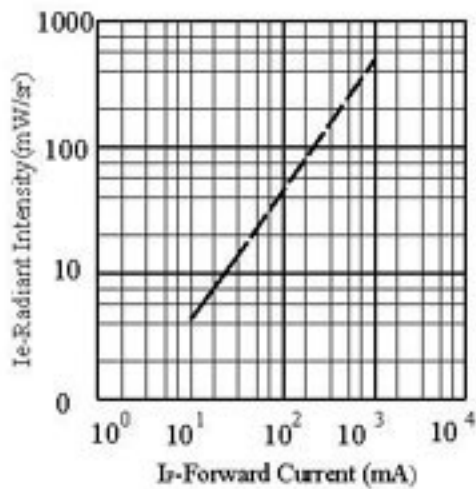

Fig.6 Relative Radiant Intensity vs.

Angular Displacement

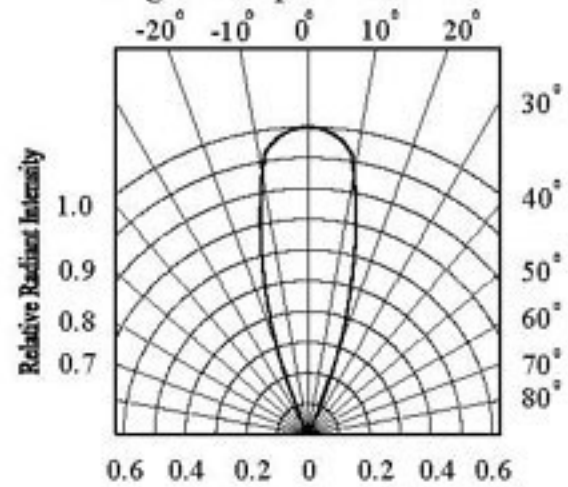

Fig.7 Relative Intensity vs.

Ambient Temperature(°C)

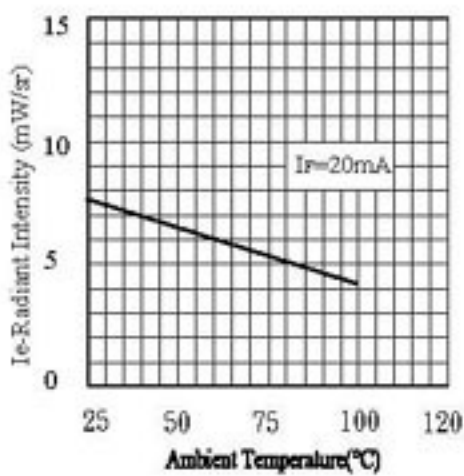
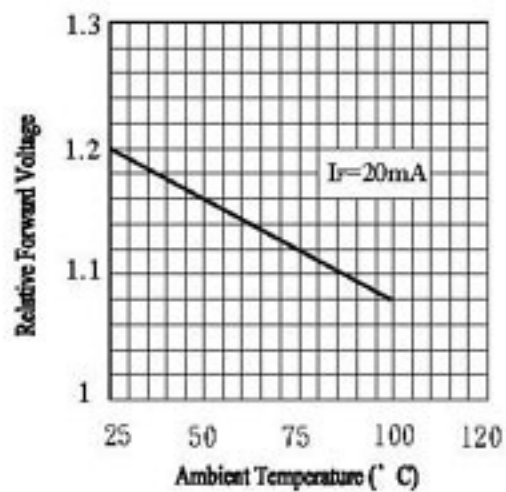

Fig.8 Forward Current vs.

Ambient Temperature(°C)



Typical Electrical/Optical/Characteristics Curves for PT

Fig.1 Collector Power Dissipation vs. Ambient Temperature

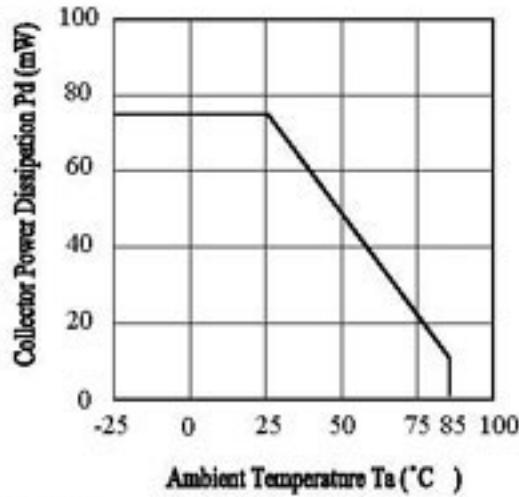

Fig.2 Spectral Sensitivity

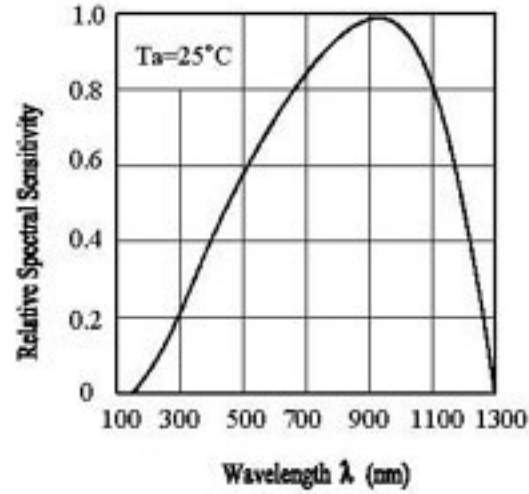

Fig.3 Relative Collector Current vs. Ambient Temperature

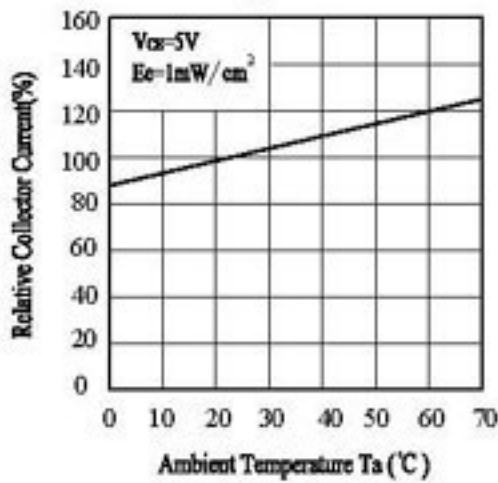

Fig.4 Collector Current vs. Irradiance

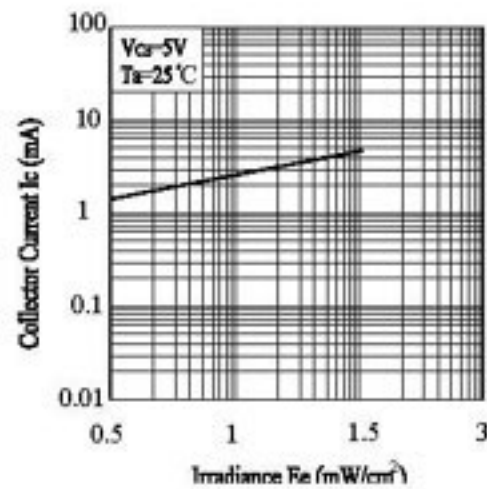

Fig.5 Collector Dark Current vs. Ambient Temperature

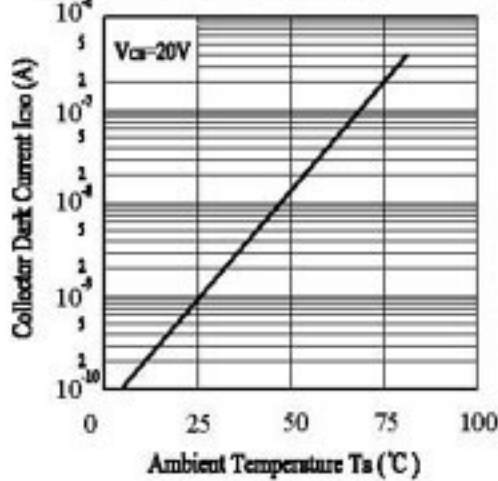

Fig.6 Collector Current vs. Collector-Emitter Voltage

